

Gardner **Denver**

EPL QuickFit

Compressed Air Piping System.



Long-Term Productivity
Lower Operating Costs



Are you spending too much to transport air?

The total expense of distributing air from your compressors to its point of use involves more than just the cost of piping.

It also includes labour-intensive installation (typically 5 times as much as the material costs), wasted energy from leak-prone systems (up to 20% to 30% after 10 years from start up), and

increased energy consumption to compensate for pressure drops (7% for every 1 barg drop).

In addition, with subsequent repairs or system upgrades costing 4 times as much as the material costs installation, it is easy to see how such hidden expenses can negatively impact your total cost of ownership.

Traditional¹ piping costs more...

Wasted Energy

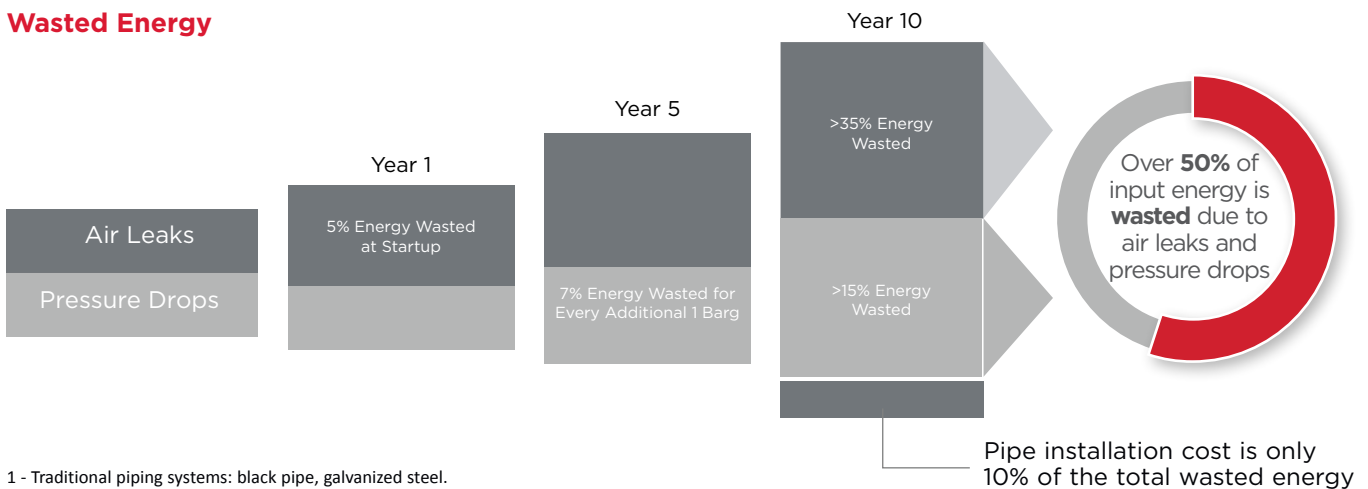

1 - Traditional piping systems: black pipe, galvanized steel.

Labour Intensive

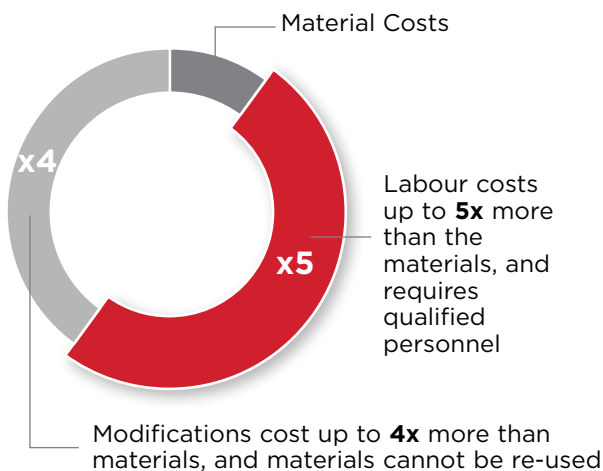

Reduced life

Rust deposits restrict airflow, compromise air quality and damage equipment.





“Choosing the right air distribution system **will lower your operating costs.**”

Gardner Denver EPL: the efficient alternative to traditional piping

The easy-to-install leak-free Gardner Denver EPL (Easy Pipe Line) system is your alternative to costly, labour-intensive steel pipe distribution systems for air, inert gas and vacuum lines. It leverages more than a century of Gardner Denver compressed air experience for streamlined installation, uncompromised reliable performance, effortless maintenance, flexibility for future needs, and maximum energy-efficiency at the lowest total cost.

Easier installation

- No special tools needed and specialised labour required
- Easy, safe installation with minimal downtime
- Patented quick-fit locking system provides fast installation and long-term operation
- Up to 60% less assembly time required than traditional piping
- 15% less assembly time required than alternative competitive modular piping systems
- Gardner Denver EPL is compatible with existing piping systems and equipment
- Compliant with 2014/68/EU PED (Pressure Equipment Directive) and ASME B31.3 Standards

Lower total cost

- Low initial investment
- Fully customisable and great configuration flexibility
- Low energy waste system, due to leak-free and low pressure drop design
- Less maintenance – up to 40% less labour and material costs than steel piping systems
- Corrosion-resistant to prevent contaminants and pressure losses
- Reusable parts for easy updates and modifications
- 10-year warranty protects your investment

The ultimate link to efficiency

Leak-free Gardner Denver EPL distribution systems are your most efficient choice for linking all aspects of Gardner Denver air system expertise – from highly efficient air compressor, air treatment, controls and tools and equipment to reliable performance.

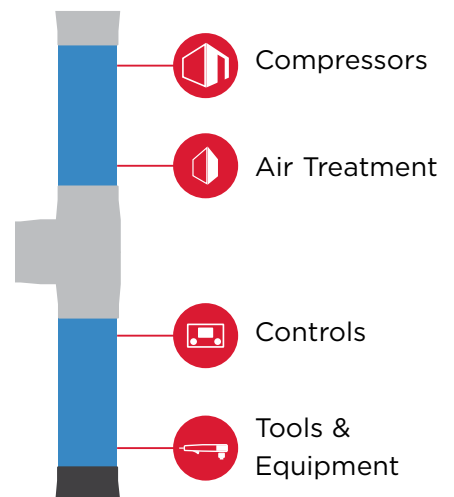

No special tools, such as labour-intensive pipe-threading equipment, are required for the EPL system.



Leak-free design, enhanced energy management

The innovative Gardner Denver EPL system offers an airtight design that eliminates wasted energy and improves efficiency and reliability. It provides superior performance, reduces your overall investment and protects your connected equipment.

Compatibility with compressor lubrication oil promotes long life.

High-quality aluminium pipe

- UV radiation resistant 6060 alloy-hardened aluminium pipe for indoor / outdoor use is significantly lighter than competing steel alternatives, making it easier to handle
- Calibrated extrusion with consistent internal dimensions and smooth internal bore minimises turbulence, reduces energy costs
- Corrosion-resistant for optimal air flow and air quality, without risk of rust particles or debris affecting sensitive equipment
- Flame-retardant powder coated finish is QUALICOAT® certified
- Standard blue painted in compliance with most industrial standards for compressed air (other colours available on request).
- Ready-to-use piping eliminates need for special labour or special tools at time of assembly

Easy-to-install quick-connect fittings

- Innovative patented locking and tightening system provides quick, secure, trouble-free installation, reducing installation lead time by 60%
- Leak-free fitting designs promote uptime by minimising routine maintenance and unexpected repairs
- Eliminating neck-downs or obstructions promotes smooth laminar flow, minimising pressure drop
- Engineered polymer hand-tightened fittings for 20-63 mm diameter systems, and heavy-duty innovative-design aluminium fittings for 80-158 mm diameter systems, both allow for easy installation, removal and reuse

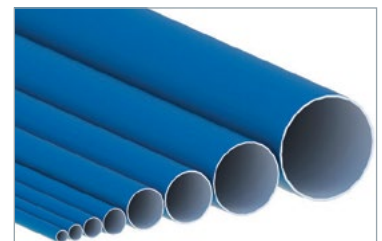

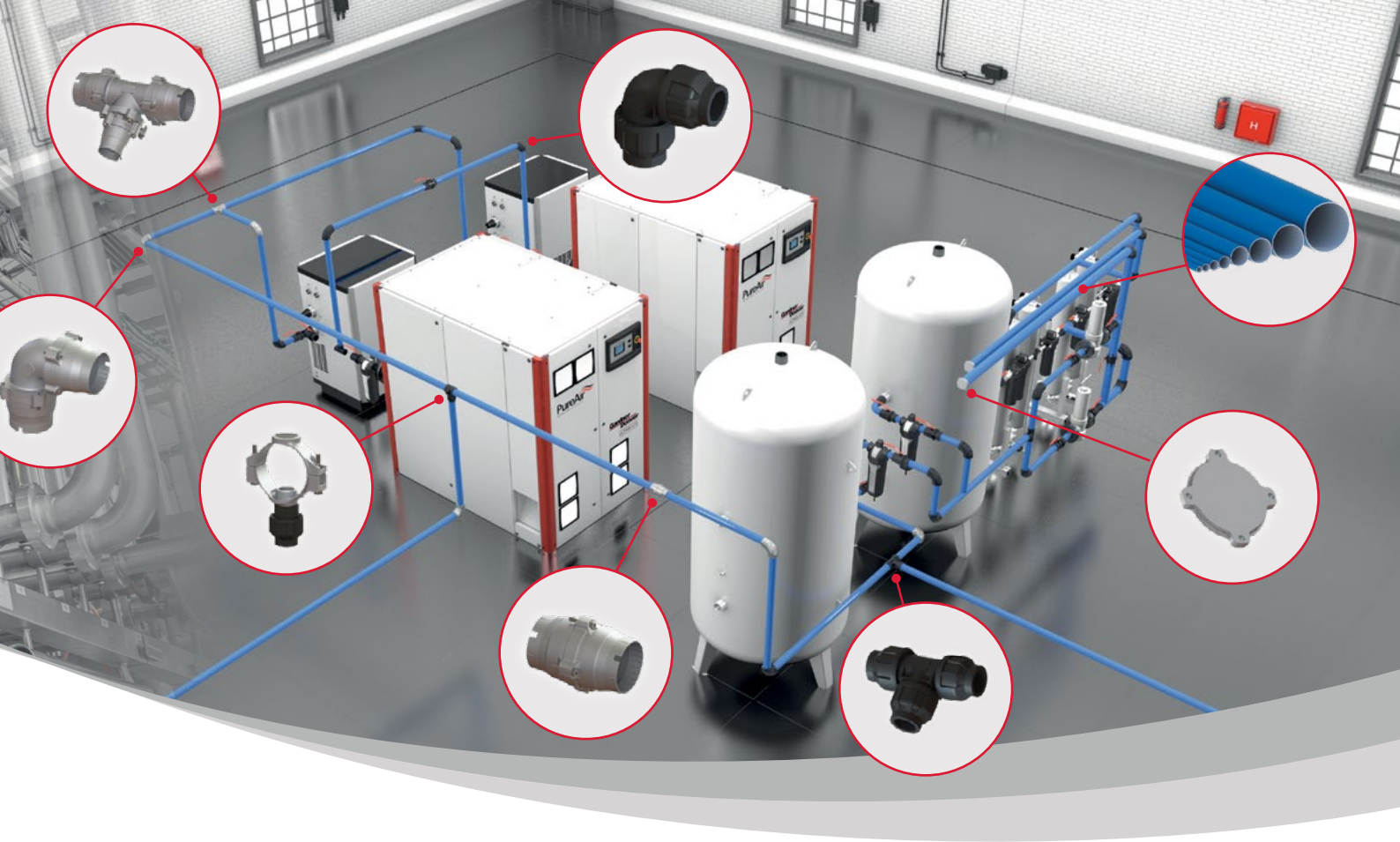

Gardner Denver EPL: simple to install

With a modular design and easy-to-assemble components, the Gardner Denver EPL piping system empowers you to easily plan and adapt your distribution piping network to the needs of your production environment.

Intuitive, easy to assemble. No special tools or qualified personnel are required to assemble leak-free Gardner Denver EPL systems.

Seamless maintenance. Patented by Gardner Denver, the innovative fitting design simplifies piping system assembly and disassembly, minimising downtime.

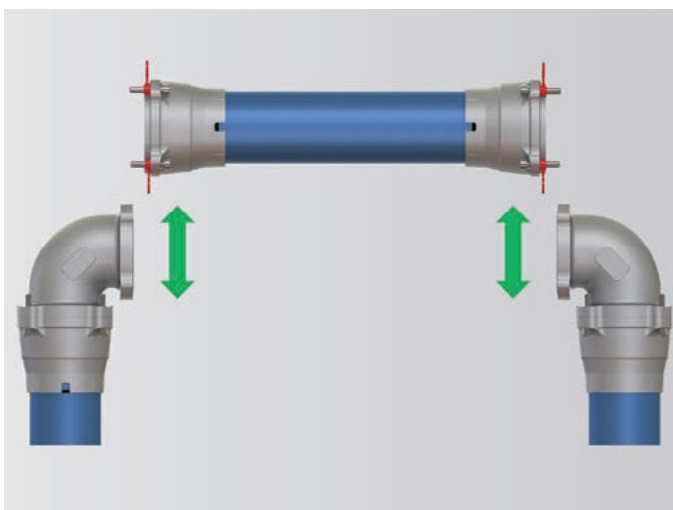

Tailored to your needs. An extensive variety of connectors, including those specifically developed for all Gardner Denver compressor and dryers ensure easy transition from current or competitive piping systems

Standardized pipe length. Pipes are supplied in 5m lengths, eliminating special transportation arrangements to improve delivery times.

Versatile configuration. A wide variety of components and accessories combined with ease-of-assembly enables swift implementation with minimal downtime.

Preassembled productivity. Fully preassembled, ready-to-use fittings reduce installation time and number of components to order and stock.

Reconfigurable. Reusable connectors minimise incremental expenses when adapting or expanding existing piping to changing requirements.

Personal support. Dedicated Gardner Denver sales personnel will ensure your questions are addressed before, during and after the system is installed.



A robust solution that provides long-term productivity

Total cost of ownership is measured by a system's service life. The unique Gardner Denver EPL system combines a proprietary Gardner Denver design, industry certifications and quality materials to provide system longevity and enhanced productivity.

Design precision for a perfect fit

The robust design of the fitting body, combined with a patented double O-ring and gasket design, ensures perfect alignment between pipe and fitting to ensure an exceptional seal.

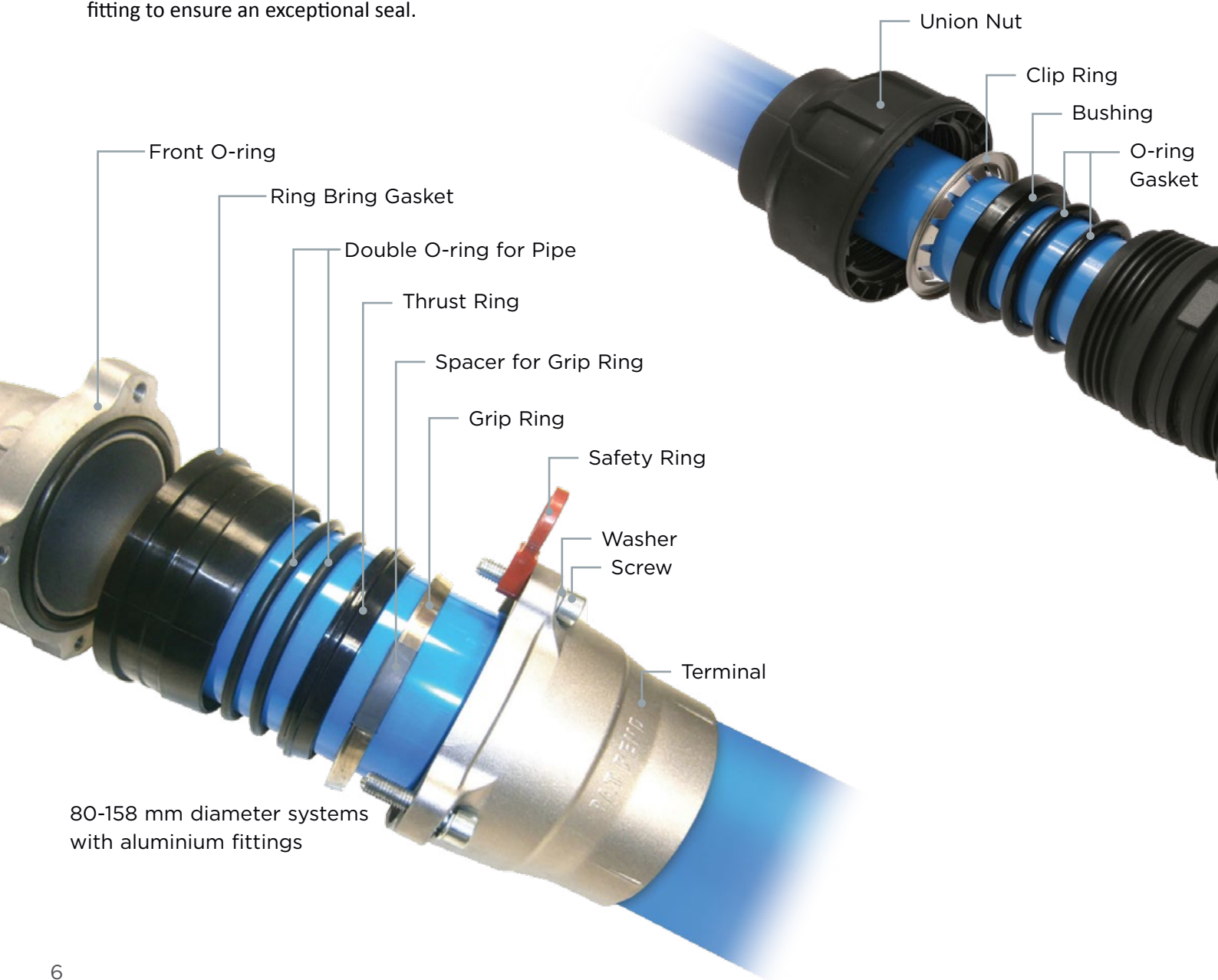

80-158 mm diameter systems with aluminium fittings



"Exceeds industry standard **MAWP** threshold by 20%!"

Reap the benefits of a unique leak-free design

The innovative design of Gardner Denver EPL fittings uses a series of precision-formed gasket, O-ring and compression components that grip and seal smooth aluminium pipes evenly around their circumference. Customised run lengths without specially grooved or threaded ends eliminate pipe preparation labour and streamline final assembly.

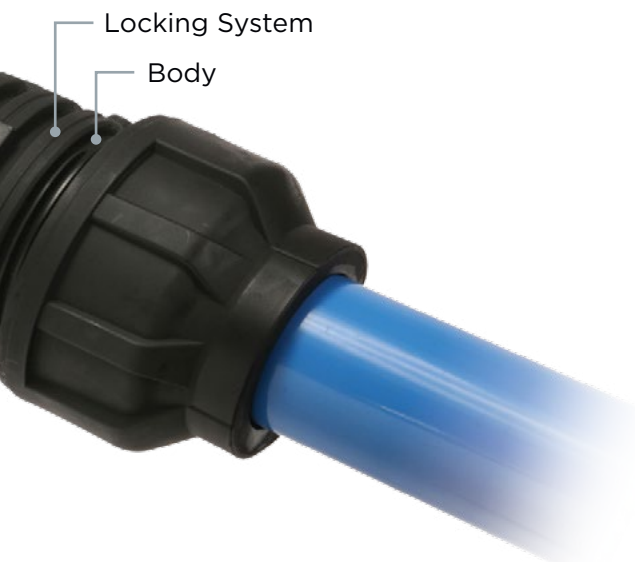

Locking System

Body

20-63mm diameter systems with engineered polymer fittings

Compliant with the most stringent design codes and certifications

Compliance with 2014/68/EU PED, ASME B31.3 and CRN pressure guidelines for structural strength and fitting design assure that Gardner Denver EPL solutions will satisfy all relevant standards for your production environment.

Our brand promise of tested-tough reliability

In the lab and in the field, the Gardner Denver EPL design has demonstrated the reliability, productivity and efficiency that are the hallmarks of all Gardner Denver products.

Innovation. Our investment in R&D has paid off with innovative ways to deliver energy-efficient air distribution systems. The patented Gardner Denver EPL design delivers leak-free performance with the convenience of fast and economical assembly and reconfiguration.

Stringent testing. To assure certified testing compliance to the highest industry standards, we designed the Gardner Denver EPL system to withstand 10 times the maximum allowable working pressure (MAWP) for the 20-63mm range, and 5 times for the 80-158mm range. Lab results show we exceeded that threshold by 20%! This provides you with the peace of mind that Gardner Denver EPL is designed to the highest quality, reliability and safety standards for operation and installation.

A 10-year warranty. Our confidence in the proven performance of Gardner Denver EPL solutions is expressed in our 10-year warranty, so that you can be equally confident of its reliability in your working environments.

Outstanding customer experience. You can depend on Gardner Denver as your one-stop source for complete air solutions – from compressor to point of use. Gardner Denver EPL components tailored to specific Gardner Denver compressors and air treatment modules are available from stock within 48 hours.

Genuine replacement parts. Our complete range of fittings and accessories assure your confidence in maintaining a reliably efficient, leak-free distribution system.

Safety at the core of our design

With precision tolerances and the highest quality materials and finishes, the Gardner Denver EPL system delivers leak-free, corrosion-resistant performance for a variety of industrial applications.

Specifications

Size (mm)	20, 25, 32, 40, 63		80, 110, 158
Max working pressure	14 bar		14 bar 12 bar for 158 mm
Max working temperature	-10°C to 60°C		-10°C to 60°C
Pipe material	Aluminium EN AW-6060 extruded and calibrated; T6 tempered UV radiation resistant – suitable to indoor/outdoor use		
Paint certification	Qualicoat® powder paint (flame retardant)		
Pipe weight	20mm 0.23 kg/m 25mm 0.30 kg/m 32mm 0.39 kg/m 40mm 0.49 kg/m 63mm 1.03 kg/m		80mm 1.58 kg/m 110mm 2.37 kg/m 158mm 4.70 kg/m
Fitting material	Engineered polymer Ultramid® B3EG6		Aluminium EN AB 42100/44100
O-ring seals	NBR 70 standard (-35°C to +110°C) VITON® optional		
Burst test pressure	130 bar		60 bar
Assembly time required	60% less than traditional piping systems 15% less than competitive modular piping systems		
Compliance	ASME B31.3 process piping 2014/68/EU PED (Pressure Equipment Directive)		
Application	Pipelines for compressed air, vacuum and inert gases (for example nitrogen or argon)		
Threads	BSP and NPT available		
Unique Gardner Denver design and patented product			



ASME B31.3
Process Piping



Qualicoat
Certified



Lloyd's Register
Tests Certification



ISO 9001:2008
Certified

PED
2014/68/EU

Ø 20-63 mm art. 3.3
Ø 80-158 mm Cat I
(Module A)



Adapters available to expand existing legacy piping systems.

Products are classified as auto-extinguished and completely recyclable, flame-proof and in accordance to all safety and health CE standards.



The flexibility to size any system

Gardner Denver EPL piping and fittings are available in eight standard sizes ranging from 20 mm to 158 mm, allowing for total configuration flexibility for your air distribution system.

All Gardner Denver EPL pipe diameters accommodate a wide range of system flows, while maintaining a pressure drop of 5% or less.

The charts below can assist you in designing a Gardner Denver EPL piping system to meet your application's specific flow-rate needs, with a pressure drop of 5% or less.

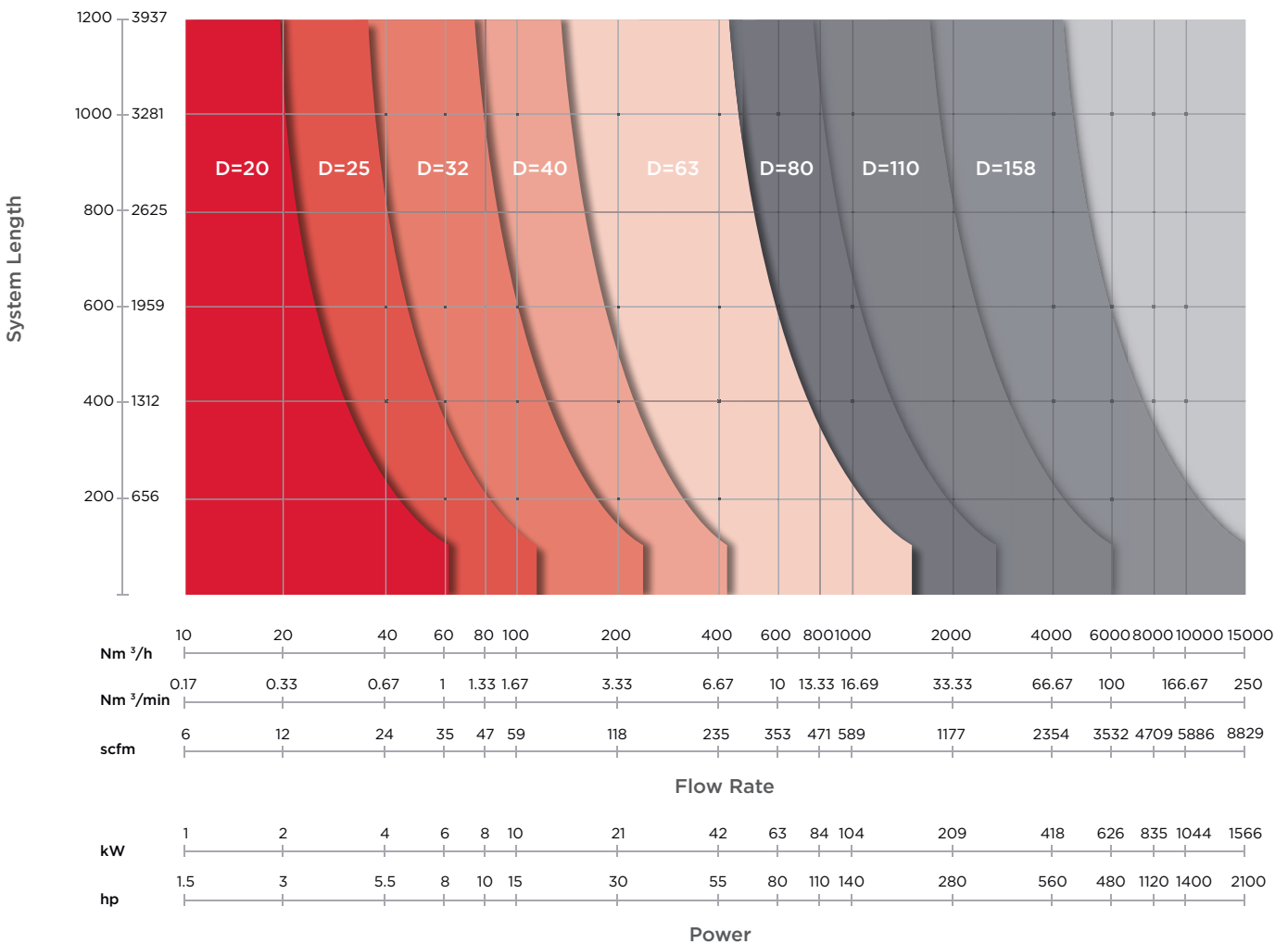

For reference only. Assumes 6.9 barg (100 psig) open loop system. Flow rate is doubled for closed loop system.

Make Gardner Denver EPL your perfect fit

The Gardner Denver EPL system offers a wide range of pipes and fittings to accommodate your unique air distribution requirements.

Image	Description	Polymer Fitting Diameter					Aluminium Fitting Diameter		
		20mm	25mm	32mm	40mm	63mm	80mm	110mm	158mm
	Aluminium Pipe	•	•	•	•	•	•	•	•
	Aluminium Pipe - S Bend	•	•						
	Straight Union	•	•	•	•	•	•	•	•
	Straight Union Pass-through	•	•	•	•	•			
	Straight Reducing		20	25	32	40	40 63	40 63 80	110
	Male Thread Connector	1/2" 3/4"	1/2" 3/4" 1"	1" 1-1/4"	1" 1-1/4" 1-1/2"	1-1/2" 2"			
	Male Thread Connector - Aluminium	1/2"	3/4"	1"	1-1/4"	2"	3"	3"	3"
	Female Thread Connector - Aluminium	1/2"	3/4"	1"	1-1/4"	2"			
	Elbow 90°	•	•	•	•	•	•	•	•
	Elbow 45°	•	•	•	•	•			
	Elbow 90° Reducing						40 63	40 63 80	110
	Elbow 90° Male Thread						3"	3"	3"
	Male Wall Elbow - Brass	1/2" 3/4"	1/2" 3/4"						
	Female Wall Elbow - Brass	1/2"	1/2"						
	End Cap	•	•	•	•	•	•	•	•
	Cap with Terminal						•	•	•
	Pipe Flange Adapter						DN80	DN100	DN150

	Description	Polymer Fitting Diameter					Aluminium Fitting Diameter		
		20mm	25mm	32mm	40mm	63mm	80mm	110mm	158mm
	Tee	•	•	•	•	•	•	•	•
	Reducing Tee		20	25	32	40	40 63	40 63 80	110
	Male Threaded Tee						3"	3"	3"
	Ball Valve	•	•	•	•	•			
	Ball Valve - Large	•	•	•	•				
	Ball Valve - Threaded Ends	1/2"	3/4"	1"	1-1/4"	2"	3"		
	Butterfly Valve						•	•	•
	Drop		20	20	20 25	20 25 32	20 25 32	20 25 32	20, 25, 32, 40, 63
	Male Drop	1/2"	1/2"	1/2" 3/4"	1/2" 3/4" 1"				
	Female Drop	1/2"	1/2"	1/2" 3/4"	1/2" 3/4" 1"	1/2" 3/4" 1"	1/2" 3/4" 1"	1/2" 3/4" 1"	1/2", 3/4", 1", 1-1/4", 2"
	2-Port Point of use Manifold Female	1/2"	1/2"						
	3-Port Point of use Manifold Female	1/2"	1/2"						
	3-Port Point of use Manifold Female 3/4" BSP + 3 x 1/2" Female BSP	1/2"	1/2"						
	Flexible Hose Female Thread	1/2"	3/4"	1"	1-1/4"	2"			
	Flexible Hose Quick Coupling						•	•	•
	Expansion Joint						•	•	•
	Plug	•	•						
	Brass Union Socket	1/2"	3/4"	1"	1-1/4"	2"			



A wide range of mounting hardware and installation tools are available.

Global Expertise

The GD rotary screw compressor range from 2.2 – 500 kW, available in both variable and fixed speed compression technologies, are designed to meet the highest requirements which the modern work environment and machine operators place on them.



The oil-free EnviroAire range from 15 – 355 kW provides high quality and energy efficient compressed air for use in a wide range of applications. The totally oil-free design eliminates the issue of contaminated air, reducing the risk and associated cost of product spoilage and rework.



A modern production system and process demands increasing levels of air quality. Our complete **Air Treatment Range** ensures the highest product quality and efficient operation.



Compressor systems are typically comprised of multiple compressors delivering air to a common header. The combined capacity of these machines is generally greater than the maximum site demand. To ensure the system is operated to the highest levels of efficiency, the **GD Connect** air management system is essential.



gdcompressors.eu@gardnerdenver.com
www.gardnerdenver.com/gdproducts

For additional information please contact Gardner Denver or your local representative.

Specifications subject to change without notice.